

BOLLY® 1 AP INOX - HIGH PERFORMANCES

STAINLESS STEEL 316L DOMESTIC HOT WATER CALORIFIER
WITH 1 FIXED STAINLESS STEEL HEAT EXCHANGER FOR DHW PRODUCTION



APPLICATION

Production and storage of domestic hot water (DHW).
All the connections are aligned on the front and on the back for quick and easy installation.

MATERIAL

Stainless Steel 316 L suitable for domestic hot water

HEAT EXCHANGER

1 Fixed stainless steel 316L heat exchanger

INSULATION

HARD: High thermal insulation with ecological polyurethane hard foam.
HARD FOAM (CLASS "A" MODELS): rigid polyurethane foam for high thermal insulation with a vacuum sheet of highly insulating material.
Grey PVC external lining.

CATHODE PROTECTION

Magnesium anode.

DRAIN

External confluence through drain connection.

GASKET- FLANGE PLATE

Silicone gaskets suitable for water intended for human consumption (tested according to 98/83/CE); Stainless steel exchanger head.

WARRANTY

5 years (See general sales conditions and warranty)

ACCESSORIES AND SPARE PARTS:

See Accessories section for the entire list.

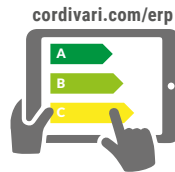
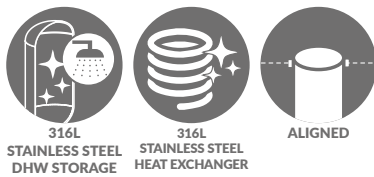

On line ErP label tool



BOLLY® 1 AP XB

Model	HARD FOAM INSULATION Art. Nr.	HEAT EXCHANGER SURFACE [m²]	ENERGY EFFICIENCY CLASS ErP
150	3104052010100	1,0	B
200	3104052010101	1,2	B
300	3104052010102	1,5	B
400	3104052010103	2,0	C
500	3104052010104	2,2	C



BOLLY® 1 AP XB CLASS A

Model	HARD FOAM INSULATION Art. Nr.	HEAT EXCHANGER SURFACE [m²]	ENERGY EFFICIENCY CLASS ErP
200	3104052010110	1,2	A
300	3104052010111	1,5	A
500	3104052010112	2,2	A

ACCESSORIES

ELECTRIC IMMERSION HEATERS

Mod.	Position of the electric heater	Heated volume by electric immersion heater [lt]	MONOPHASE		
			1,5 kW	2 kW	3 kW
150	1	126	5240000000051	5240000000052	5240000000053
	2	46			
200	1	161			
	2	53			
300	1	237			
	2	83			
400	1	356			
	2	138			
500	1	417			
	2	150			

MONOPHASE		
1,5 kW	2 kW	3 kW
Ignition time from 10 °C to 45 °C with electric immersion heaters [min]		
225	169	113
82	61	41
288	216	144
94	71	47
425	319	213
148	111	74
637	478	318
247	185	124
746	560	373
269	202	135

THREEPHASE		
4 kW	5 kW	6 kW
Ignition time from 10 °C to 45 °C with electric immersion heaters [min]		
5240000000047	5240000000048	5240000000049
//	//	//
31	//	//
//	//	//
35	//	//
159	//	//
56	45	//
239	//	//
93	74	//
280	224	//
101	81	67

Titanium electronic anode

For art. nr. and prices please see Accessories section



BOLLY® 1 AP INOX - HIGH PERFORMANCES

STAINLESS STEEL 316L DOMESTIC HOT WATER CALORIFIER

WITH 1 FIXED STAINLESS STEEL HEAT EXCHANGER FOR DHW PRODUCTION

STORAGE		HEAT EXCHANGER	
Pmax	Tmax	Pmax	Tmax
6 bar	95 °C	12 bar	110 °C



CORDIVARI Lab

TÜV Rheinland Energie und Umwelt GmbH states that test procedures and Cordivari LAB are certified conforming to European standard EN 15332, as indicated by Ecodesign ErP Directive.

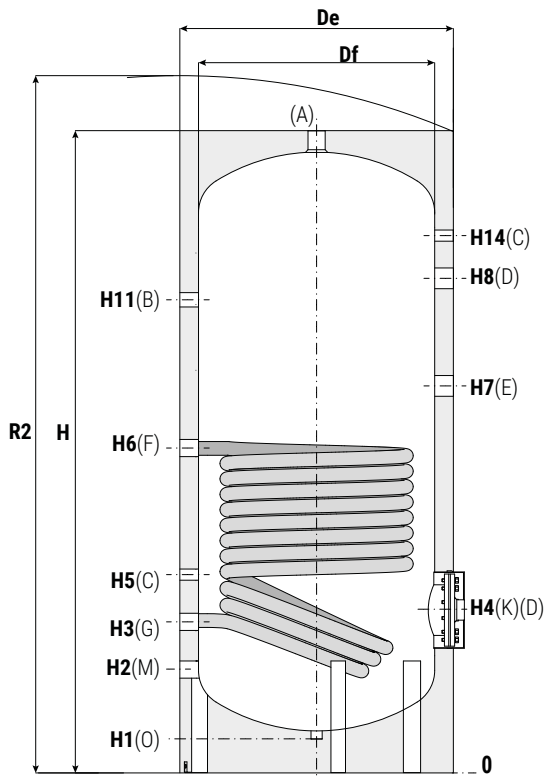
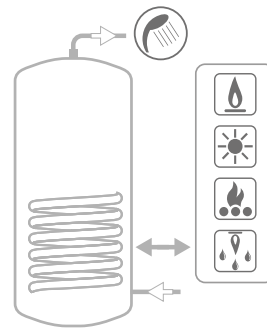

- A** Domestic hot water outlet
- B** Recirculation
- C** Connection for instrumentation 1/2" G F
- D** Connection for electric immersion heater
- E** Connection for magnesium anode 1"1/4 G F
- F** Primary circuit inlet 1" G F
- G** Primary circuit outlet 1" G F
- K** Flange for inspection
- M** Domestic cold water circuit inlet
- O** Drain

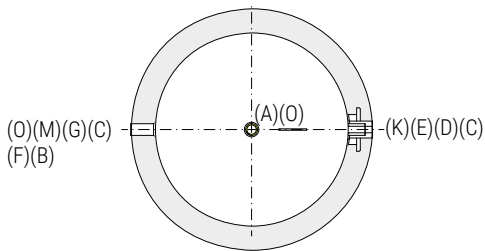

BOLLY® 1 AP INOX - 1 AP INOX CLASS A (HARD FOAM INSULATION-XB)

Model	Volume [lt]	Weight [kg]	Df	De	H	R2	H1	H2	H3	H4	H5	H6	H7	H8	H11	H14
150	150	35	400	500	1420	1510	65	205	310	310	420	719	830	960	1060	1180
200	192	41	450	550	1440	1540	65	215	320	320	430	780	880	1010	1094	1200
300	293	59	550	650	1495	1630	70	245	350	380	460	750	910	1040	1110	1230
400	425	79	600	700	1170	1360	65	255	360	390	470	895	1040	1170	1325	1480
500	503	84	650	750	1796	1950	65	265	370	480	405	1060	1090	1220	1335	1490

Model	A	B	C	D	E	F	G	K	M	O
150	1"	3/4"	1/2"	1"1/2"	1"1/4"	1"	1"	Øi120/Øe180	3/4"	1/2"
200	1"	3/4"	1/2"	1"1/2"	1"1/4"	1"	1"	Øi120/Øe180	3/4"	1/2"
300	1"	1"	1/2"	1"1/2"	1"1/4"	1"	1"	Øi120/Øe180	1"	1/2"
400	1"	1"	1/2"	1"1/2"	1"1/4"	1"	1"	Øi120/Øe180	1"	1/2"
500	1"	1"	1/2"	1"1/2"	1"1/4"	1"	1"	Øi120/Øe180	1"	1/2"

BOLLY® 1 AP INOX - HIGH PERFORMANCES

HEAT EXCHANGERS TECHNICAL DATA



Data have been calculated on following basis:

- 1) Primary circuit at T1 and proper energy source;
- 2) Production of DHW in continuous from 10 °C to t2;
- 3) DHW that can be taken in the first 10' and in the first hour from storage at t2, input 10 °C and output 45 °C;
- 4) Sanitary water according to UNI CTI 8065 (<15°fr).

LOWER
HEAT EXCHANGER

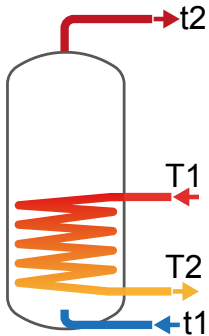

Model	Primary Flow rate [m³/h]	Ignition time (minutes) from 10 °C to t2 and primary at T1				Maximum power exchange (kW) with primary at T1, secondary within 10-45 °C and constant use of DHW production				DHW continuous production lt/h within 10-45 °C and primary at T1			
		T1/t2				T1				T1			
		55/50	65/60	70/60	80/60	55	65	70	80	55	65	70	80
150	2	65	68	47	30	8,9	11,3	14,4	20,1	188	191	245	345
	1	76	78	55	36	8,3	10,5	13,2	18,1	173	176	224	310
200	2,5	65	68	47	31	11,3	14,3	18,2	25,4	240	243	315	438
	1,25	75	78	55	36	10,6	13,4	16,8	23,1	223	227	287	397
300	3	79	82	57	37	14,3	18,0	22,9	32,0	304	308	394	553
	1,5	90	94	66	43	13,4	16,9	21,3	29,2	284	289	366	504
400	3,5	85	89	62	41	19,1	24,0	30,1	42,7	408	414	529	739
	1,75	99	103	72	48	17,9	22,6	28,4	38,9	383	389	491	673
500	3,5	93	96	68	45	20,9	26,4	33,6	46,6	448	454	580	809
	1,75	108	113	80	53	19,6	24,8	31,1	42,3	420	427	537	734

Model	Primary Flow rate [m³/h]	DHW produced in the first 10 minutes in lt/10' input 10 °C output 45 °C, storage at t2 and primary at T1				DHW produced in the first hour in lt/60' input 10 °C output 45 °C, storage at t2 and primary at T1				Heat exchanger pressure drop	
		T1/t2				T1/t2				[mm.c.a.]	[mbar]
		55/50	65/60	70/60	80/60	55/50	65/60	70/60	80/60		
150	2	202	245	254	270	321	323	366	446	342	34
	1	199	242	250	265	309	311	349	418	100	10
200	2,5	258	313	325	346	410	413	470	569	623	61
	1,25	255	311	321	339	397	400	448	536	183	18
300	3	386	470	484	511	578	581	650	777	1057	104
	1,5	382	467	480	503	562	566	628	738	311	30
400	3,5	554	676	695	730	812	817	909	1077	1817	178
	1,75	550	672	689	719	792	797	879	1024	536	53
500	3,5	650	794	815	853	933	938	1039	1222	1989	195
	1,75	645	790	808	841	911	916	1004	1162	587	58

HEAT EXCHANGERS PRESSURE DROP

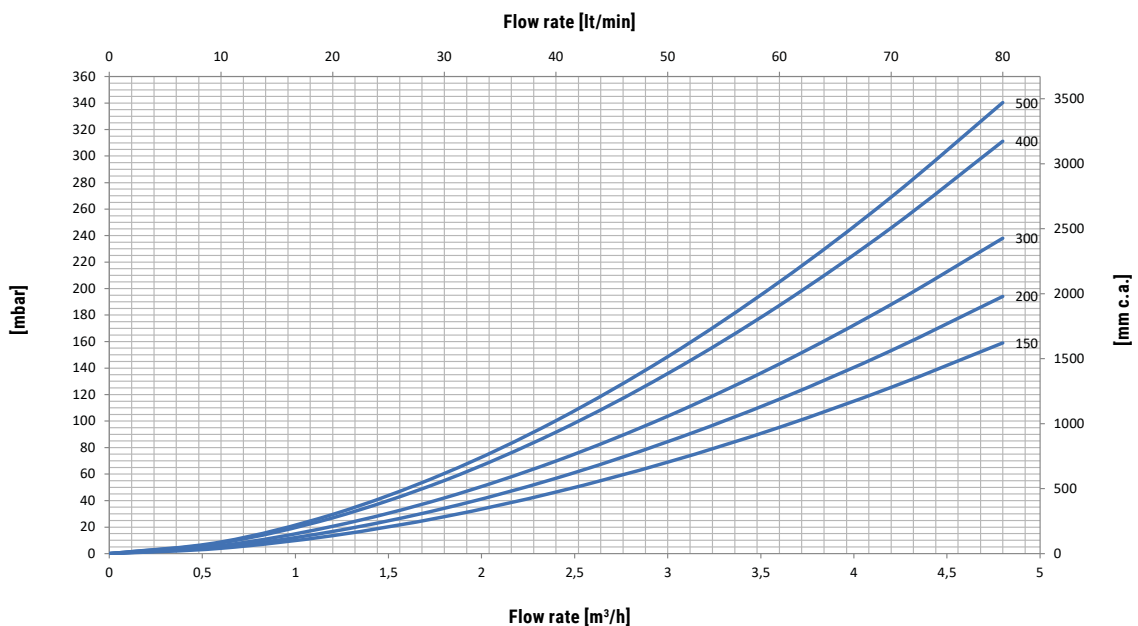

BOLLY® 1 AP INOX - HIGH PERFORMANCES

HEAT EXCHANGERS TECHNICAL DATA



Heat Exchanger output referred to temperature and flow rate of primary circuit and with secondary at 10/45°C at maximum withdrawal of producible DHW (Upper limit of the curves referred to maximum primary flow rate in the heat exchanger, while the lower limit in the curves refer to the minimum primary flow rate).

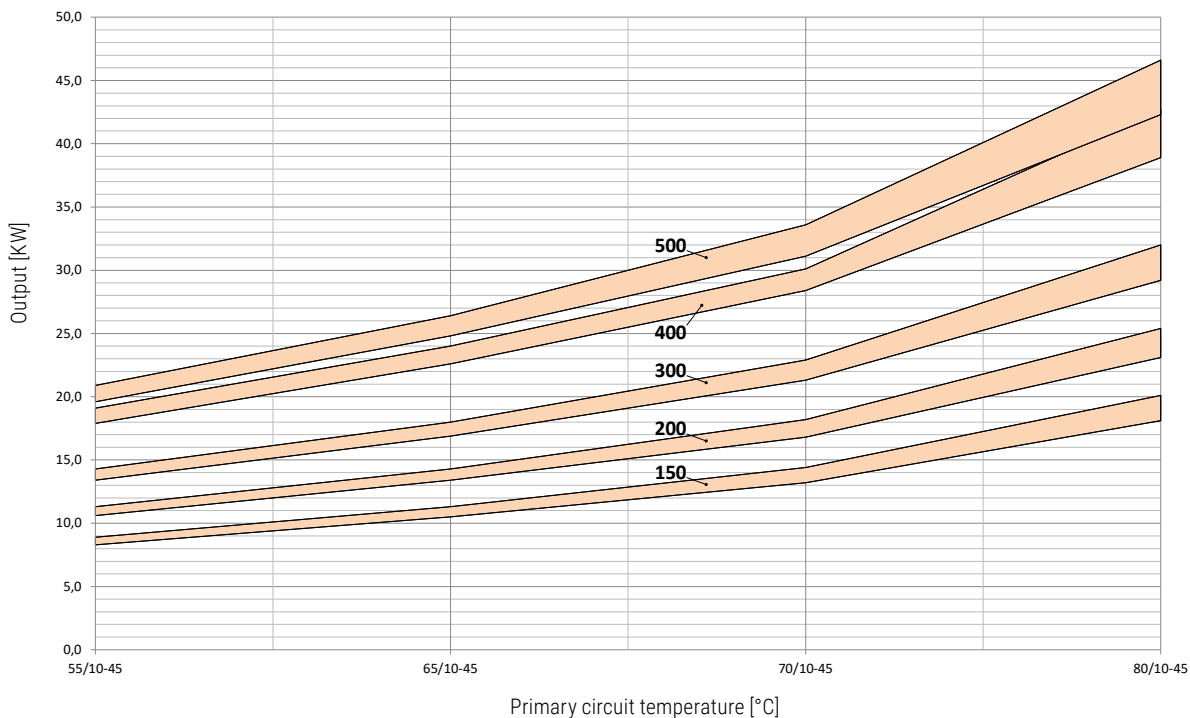

Model Bolly® 1 AP XB	150		200		300		400		500	
	MAX	MIN	MAX	MIN	MAX	MIN	MAX	MIN	MAX	MIN
Flow rate [m³/h]	2	1	2,5	1,25	3	1,5	3,5	1,75	3,5	1,75

EXAMPLE OF INSTALLATION WITH BOLLY® 1 AP INOX - HIGH PERFORMANCES

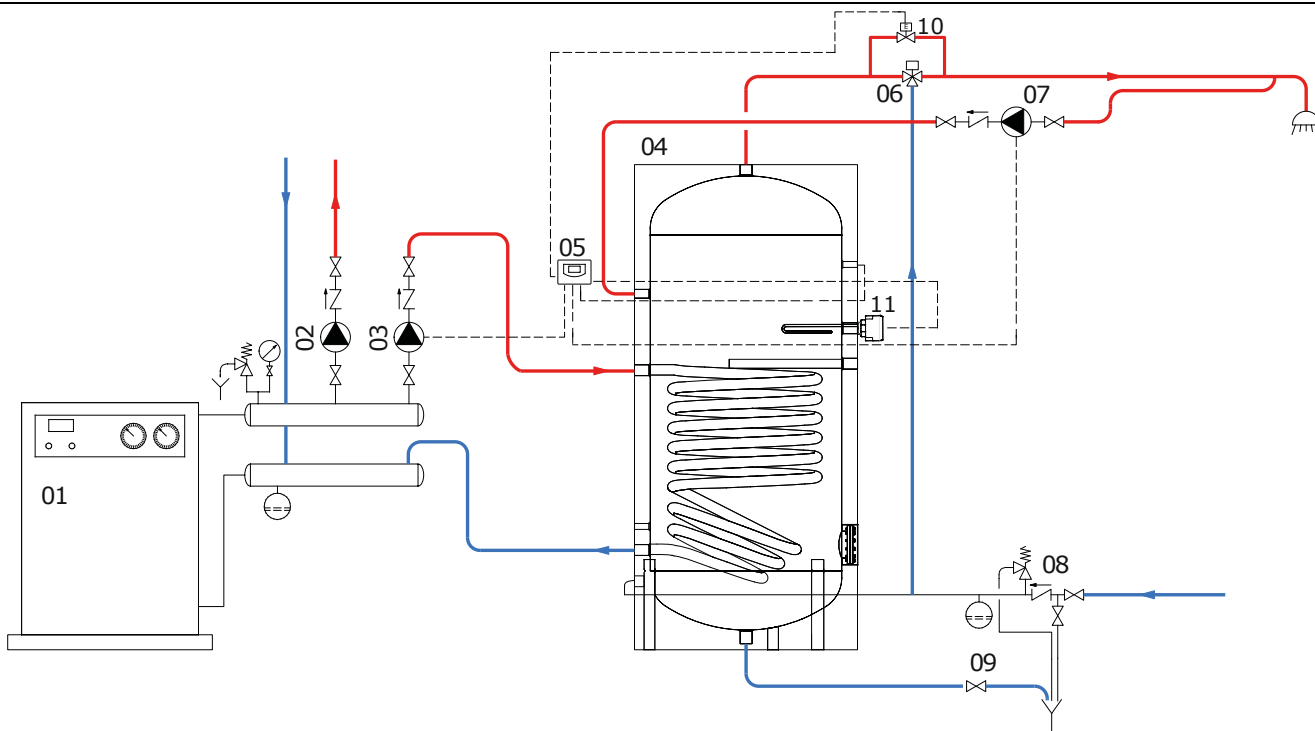

01	Generator	04	BOLLY® 1 AP INOX	07	D.H.W. recirculation group	10	By-pass solenoid valve
02	Heating system circulation group	05	Electronic control /thermostat	08	Hydraulic safety group	11	Electric immersion heater (optional)
03	D.H.W. circulation group	06	Thermostatic mixing valve	09	Blowdown valve		

The following schemes are purely illustrative. To realize the installation, always refer to a qualified technician.